



FlashPoint dual directional copy technology

FlashPoint ShareDrive FP01-XXX Series

ShareDrive

Quick Start Guide

Rev. 01

Congratulations on your purchase of FlashPoint!

1. Checking the package contents

Your package contains one each of the following items:

- FlashPoint ShareDrive
- Integrated Battery
- Cap
- USB Cable
- Neck Strap
- Quick Start Manual

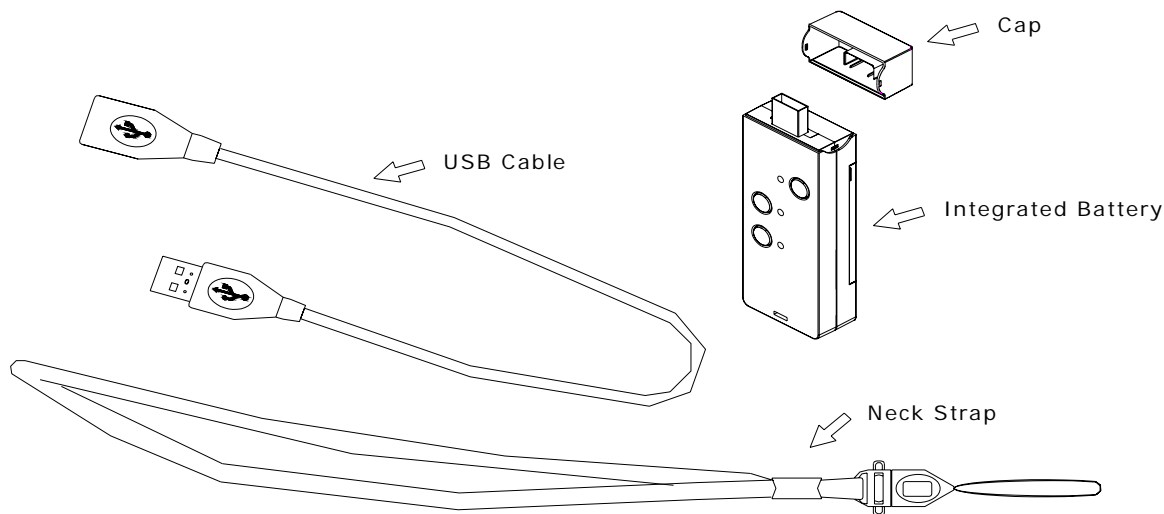

Quick Start

2. You must charge your ShareDrive

Simply insert the ShareDrive into a personal computer or notebook to charge. The initial battery charge should be at least 6-8 hours. The POWER LED will flash when charging and will stay on when fully charged. After the ShareDrive is fully charged, you must “format” it before using.

- Full-charge time: About 2 hours.
- Recharge time: 1 hour.
- Transfers: Approximately 50,000.

- **IF YOU NEED TO USE ANY EXTERNAL CHARGERS OTHER THAN A PERSONAL COMPUTER or NOTEBOOK TO CHARGE THE FLASHPOINT SHAREDRIVE, IT IS RECOMMENDED TO USE XMULTIPLE'S PROPRIETARY FLASHPOINT SHAREDRIVE CHARGERS ONLY.**

(Using another manufacture's charger may cause damage to your ShareDrive therefore voiding the 90-day warranty)

3. Formatting the FlashPoint ShareDrive

Step 1: Insert your ShareDrive into a personal computer or notebook.

Step 2: Locate your ShareDrive in *My computer*. Then right click to select "format" in the list.

Step 3: Click "Start" to proceed formatting. Your ShareDrive will be ready to use when the process is completed.

Step 4: Create a folder named "Share"

4. Using your USB ShareDrive

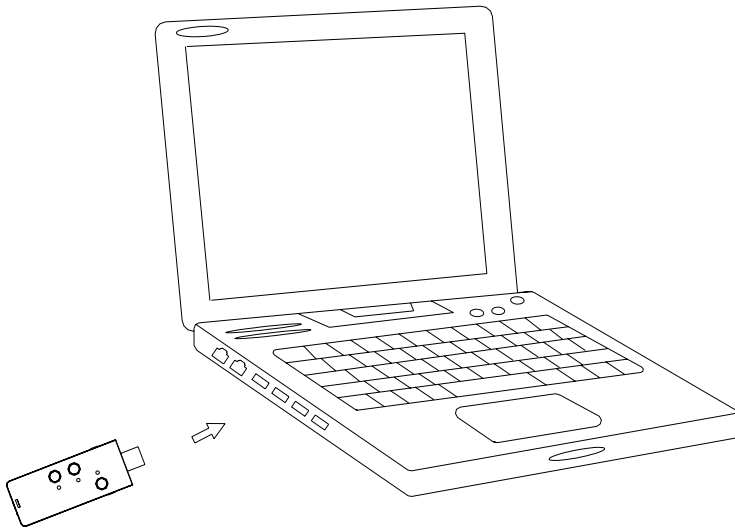

Plug your FlashPoint ShareDrive into your Personal Computer or Notebook for data transferring and deleting. If the data is unreadable, please remove your ShareDrive from your Personal Computer or Notebook, and then repeat this process.

5. Transferring data to and from your ShareDrive

In both cases, before you can transfer data, you must do the following:

Insert your thumb drive into your ShareDrive. The "SHARE LIGHT" (LED) will flash three times and will stay on confirming that you have a connection (as shown in step 2).

NOTE: For data privacy protection purpose, in order to transfer the selective data to the others, you must first create a folder named "SHARE" in your ShareDrive and have the selective data saved in this folder, or none of the data will be able to transfer.

5.1 How to operate "Share" function

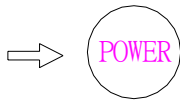
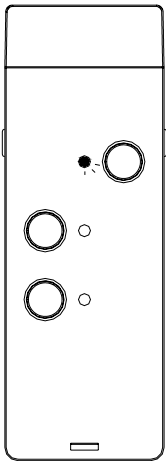

Step 1: To turn on the power:
hold the "POWER" button for
three seconds and release the
button. The POWER LED will stay
on.

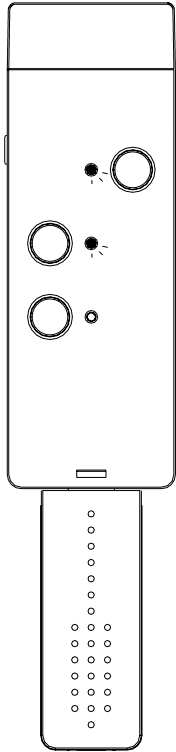

Step 2: Connect your Thumb Drive to your ShareDrive's female USB connector. When connected, the SHARE LED will flash three times and will stay on when ready.

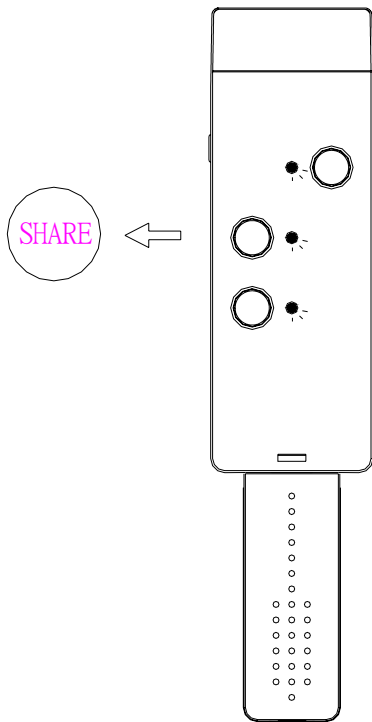

Step 3: Press the "SHARE" button to transfer data from the ShareDrive to a Thumb Drive or another ShareDrive. While transferring, the LOAD LED will flash continuously and will stop flashing when the data transfer is completed. The SHARE LED will stay on until the unit is disconnected from the ShareDrive.

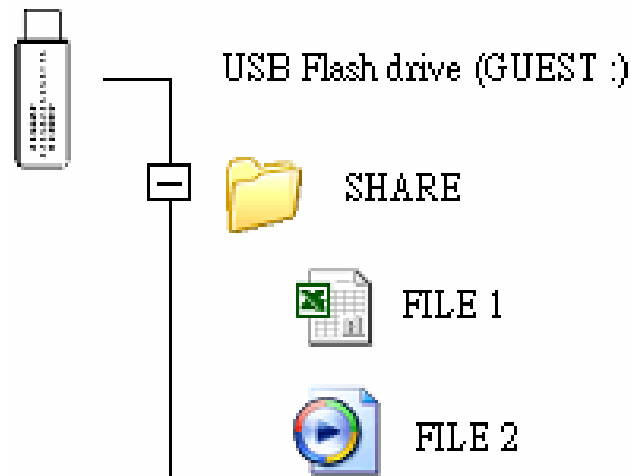
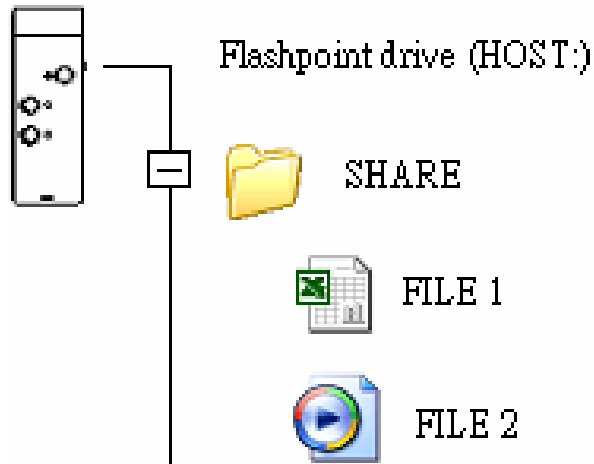

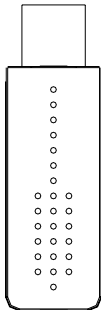
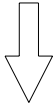
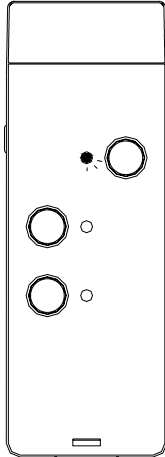

Step 4: To disconnect, simply remove the Thumb Drive from the ShareDrive.

5.2 How to operate "Load" function

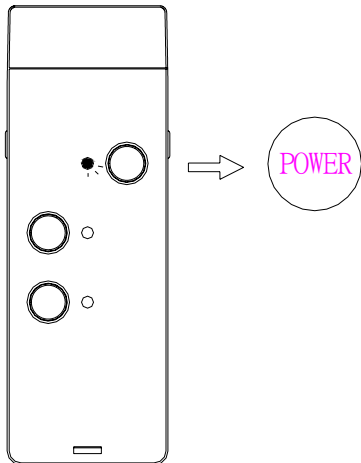

Step 1: To turn on the power: hold the "POWER" button for three seconds and release the button. The POWER LED will stay on.

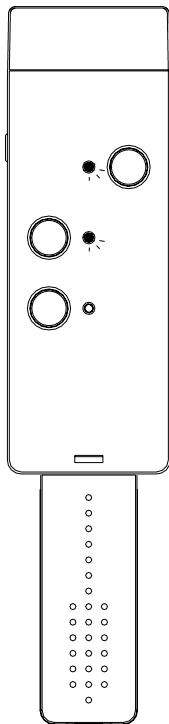

Step 2: Connect the Thumb Drive or another ShareDrive to the female USB connector. When connected, the SHARE LED will flash three times and will stay on when ready.

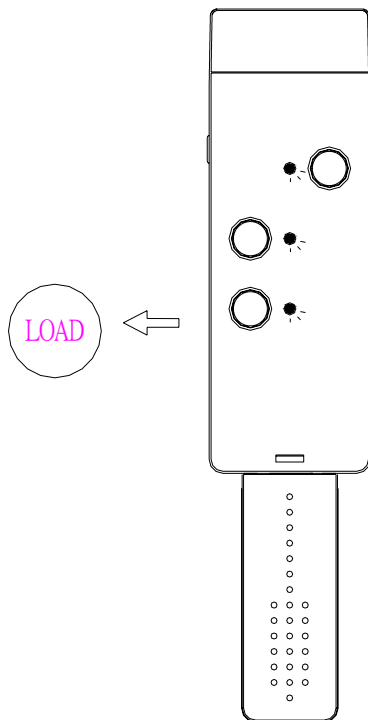

Step 3: Press the “LOAD” button. Data will transfer from the Thumb Drive to the ShareDrive. While transferring, the LOAD LED will flash continuously until transfer is completed. (To download specific data it must be stored in a folder titled “Download”; your FlashPoint ShareDrive will only transfer the information within Download folder and leave the other data in your thumb drive alone. On the other hand, to transfer all data simply remove the Download folder.)

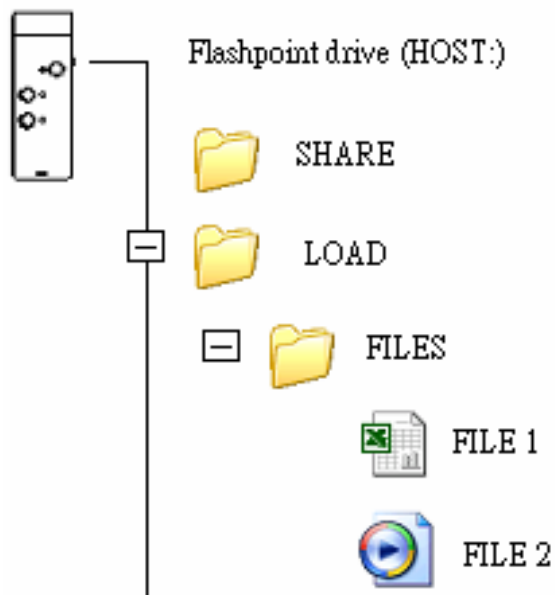
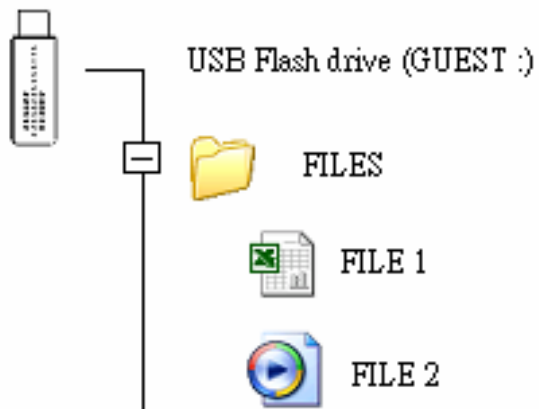

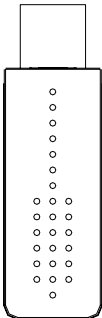
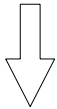
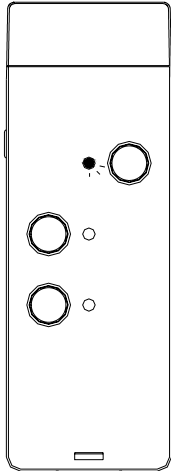

Step 4: To disconnect, simply remove the Thumb Drive from the ShareDrive.

6. How to operate "Reset" function

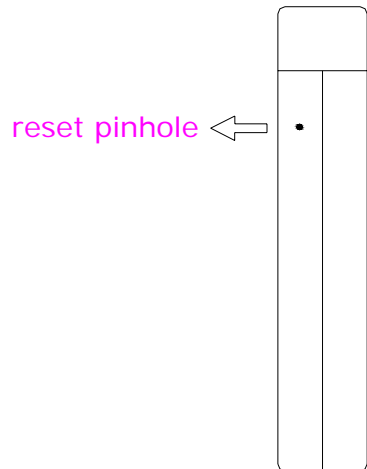

When encountering a corruption problem while transferring data, simply reset your ShareDrive by accessing the "reset pinhole" on the right hand side of the ShareDrive.

7. Tips and Troubleshooting

*If an Error occurs the red light appears when the unit is powered on. This means the third party device is not connected properly to the FlashPoint to operate "Share" or "Download" function.

Solution : Disconnect third party device. Turn off the FlashPoint ShareDrive power, reconnect the party device. Power on the FlashPoint ShareDrive. When green power light turns green, then it's ready for the "Share" or "Download" function.

*When ready, but an Error red light is flashing, this means there is not enough space available in the FlashPoint to enable the "Share" or "Download" function.

Solution : Either to turn off the power or remove the third party device from the FlashPoint. Then free up space on the FlashPoint ShareDrive or the third party device. There must be available unused capacity on both the FlashPoint ShareDrive and the third party device for the "Share" or "Download" to complete their copying function.

*When ready, but an orange-red light appears, this means the third party device is either locked or Digital Still Camera is in Picture Transfer Protocol transferring format.

Solution : Turn off the power and remove the third party device from the FlashPoint. Unlock the third party device or switch Digital Still Camera into ordinary transferring format. Connect the third party device to FlashPoint again and wait until the light becomes a steady green, then you can do the next data transferring.